

Ethernet I/O Modules: ADAM-6000

Vertrieb durch



AMC – Analytik & Messtechnik GmbH Chemnitz

Heinrich-Lorenz-Str. 55 Tel.: +49/371/38388-0
09120 Chemnitz Fax: +49/371/38388-99
E-Mail: info@amc-systeme.de Web: www.amc-systeme.de

Ethernet I/O Modules

ADAM-6000 Series	Ethernet I/O System Introduction	19-2
ADAM-6000 Features: GCL		19-3
ADAM-6000 Features: Peer-to-Peer		19-4
ADAM-6000 Series Selection Guide		19-5
ADAM-6015	7-ch Isolated RTD Input Modbus TCP Module	
ADAM-6017	8-ch Isolated Analog Input Modbus TCP Module with 2-ch DO	19-6
ADAM-6018	8-ch Isolated Thermocouple Input Modbus TCP Module with 8-ch DO	
ADAM-6050	18-ch Isolated Digital I/O Modbus TCP Module	
ADAM-6051	14-ch Isolated Digital I/O Modbus TCP Module with 2-ch Counter	19-7
ADAM-6052	16-ch Source-type Isolated Digital I/O Modbus TCP Module	
ADAM-6060	6-ch Digital Input and 6-ch Relay Modbus TCP Module	19-8
ADAM-6066	6-ch Digital Input and 6-ch Power Relay Modbus TCP Module	
ADAM-6000 Series Common Specifications		19-8

Real-time Ethernet I/O Modules

EtherNet/IP & PROFINET I/O Module Introduction		19-9
ADAM-6100 Series Selection Guide		19-10
ADAM-6117	8-ch Isolated Analog Input Real-time Ethernet Module	
ADAM-6124	4-ch Analog Output Real-time Ethernet Module	19-11
ADAM-6150	15-ch Isolated Digital I/O Real-time Ethernet Module	
ADAM-6151/6156	16-ch Isolated Digital Input/ Digital Output Real-time Ethernet Module	19-12
ADAM-6160	6-ch Relay Real-time Ethernet Module	

Intelligent Ethernet I/O Modules

ADAM-6200 Series	Introduction	19-13
ADAM-6200 Key Features		19-14
ADAM-6200 Series Selection Guide		19-15
ADAM-6217	8-ch Isolated Analog Input Modbus TCP Module	
ADAM-6218	6-ch Thermocouple Input Modbus TCP Module	19-16
ADAM-6224	4-ch Isolated Analog Output Modbus TCP Module	
ADAM-6250	15-ch Isolated Digital I/O Modbus TCP Module	
ADAM-6251	16-ch Isolated Digital Input Modbus TCP Module	19-17
ADAM-6256	16-ch Isolated Digital Output Modbus TCP Module	
ADAM-6260	6-ch Relay Output Modbus TCP Module	19-18
ADAM-6266	4-ch Relay Output Modbus TCP Module with 4-ch DI	

To view all of Advantech's Ethernet I/O Modules: ADAM-6000, please visit www.advantech.com/products.



ADVANTECH
Premier Partner

ADAM-6000 Series

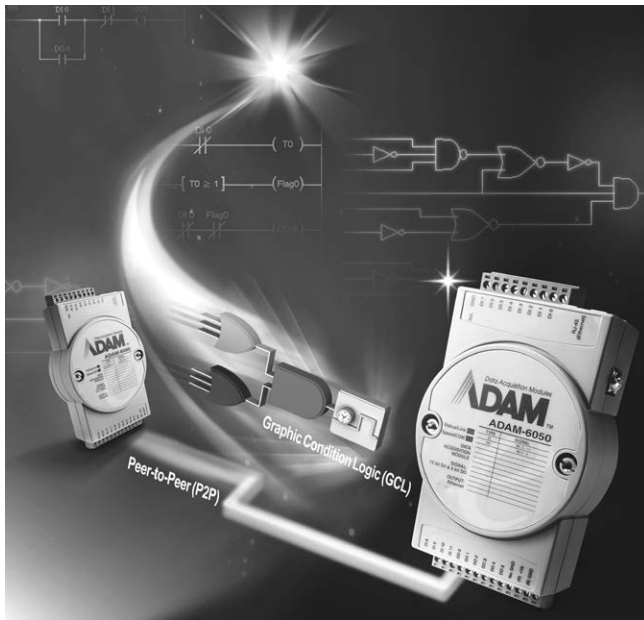

Features

- Ethernet-based smart I/O
- Mixed I/O in single module
- Pre-built HTTP server and web pages in each module
- Active I/O message by data stream or event trigger function
- Industrial Modbus/TCP protocol
- Easily update firmware through Ethernet
- ADAM.NET Class Library for .NET application
- Intelligent control ability by Peer-to-Peer and GCL function

The Path to Seamless Integration

The integration of automation and enterprise systems requires a change in the architecture of open control systems. From Advantech's point of view, the level of integration between automation and enterprise systems can only be accomplished through Internet technology. It is believed that IP/Ethernet protocols will progress beyond the control layer, into the field layers. Placing remote I/O with IP/Ethernet connections on the shop floor is economical. Advantech believes that over the next five years, Internet protocols over Ethernet will dominate major field connections. The Advantech ADAM-6000 series offers ideal remote I/O solutions with Internet protocols for industrial automation environments.

ADAM-6000 firmware features a built-in Modbus/TCP server. Advantech provides the ADAM.NET Utility, ADAM.NET class library and OPC Server for the ADAM-6000 series to support these functions as well. Users can configure DA&C systems via ADAM.NET Utility and integrate it with an HMI software package via Modbus/TCP driver or Modbus/TCP OPC Server. Furthermore, users can easily use the ADAM.NET class library to develop their own applications.

Web-enabled Technology Becomes Popular on Factory Floors

As Internet technologies and standards have rapidly developed over the past decade, Web-based control methodologies now obviously represent a powerful opportunity for extending efficient network-based management techniques to encompass non-IT real-world assets.

The ADAM-6000 series is equipped with a built-in web server so that its data can be viewed, anytime-anywhere via the Internet. Moreover, the ADAM-6000 series allows users to configure user-defined web pages to meet the diverse needs in various applications. With this powerful function, the ADAM-6000 series breaks the boundary of traditional multi-layer automation architecture and allows users to access field data directly in real time, which enables seamless integration between the plant floor and the front office.

HMI has provided a friendly operator interface for discrete control and sharply reduced the cost and complexity of automation systems. A web server has been added to most HMI software and a browser allows access to HMI displays from remote locations via the network. The end user is able to see and use an identical HMI from any Internet connected computer anytime, anywhere. ADAM-6000 series can be fully integrated with standard HMI software which supports Modbus/TCP.

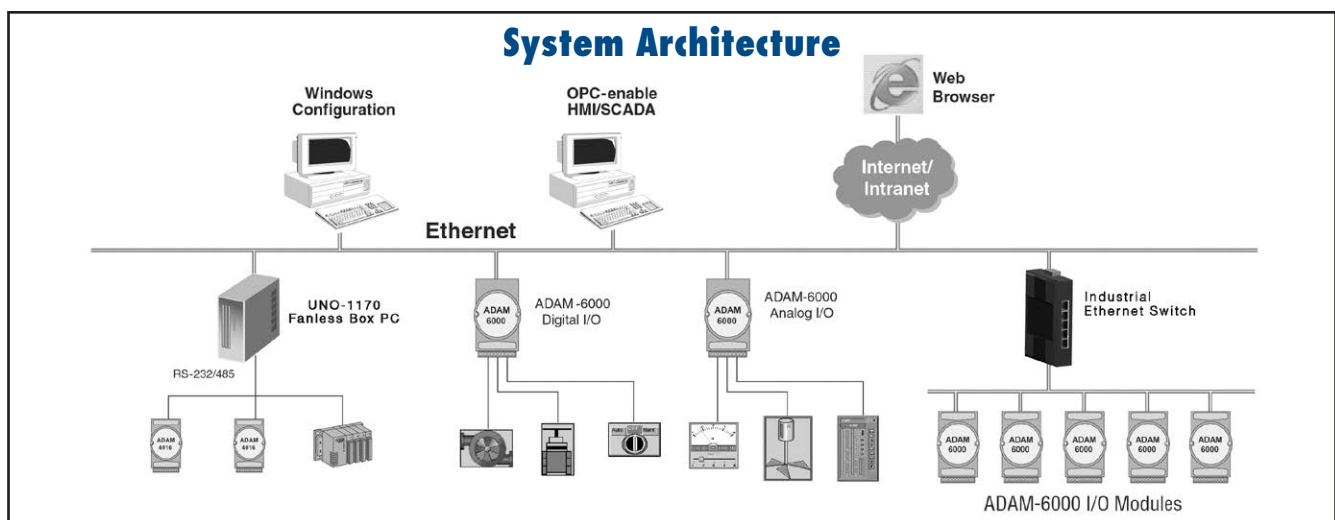

ADAM-6000 Features: GCL

Using Ethernet I/O Modules as Controllers

What is GCL?

GCL (Graphic Condition Logic) gives Ethernet I/O modules control ability. Users can define the control logic rules using graphic configuration environment in ADAM.NET Utility, and download defined logic rules to ADAM-6000 Ethernet I/O modules. Then, that Ethernet I/O module will execute the logic rules automatically just like a standalone controller.

For each Ethernet I/O module, 16 logic rules can be defined. In the configuration environment of ADAM.NET Utility, four graphic icons shows the four stages of one logic rule: Input, Logic, Execution and Output (Refer to figure below). Users can simply click on each icon and one dialog window will pop-up for users to configure each stage. After completing all configurations, users can click one button to download the defined logic rules to the specific Ethernet I/O module.

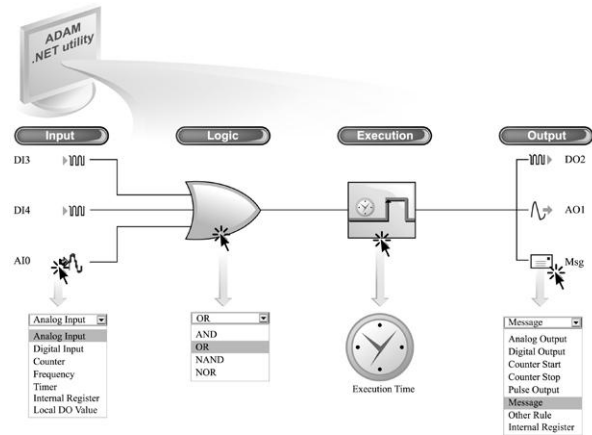

ADAM-6000 GCL is the Simplest Logic Ethernet I/O

Complete Graphic Configuration Environment

Unlike other text-based logic configuration utility, Advantech GCL provides a complete graphic configuration utility, which is very intuitive to use. By simply clicking the icons, all related configurations can be done through the pop-up dialog window. GCL is not only easy-to-use, but is also features very powerful functionality.

Supports Both Local and Remote Output

When users define the destination of Output stage (such as digital output, analog output, counter and pulse output), users can choose either the local module or another remote module as target.

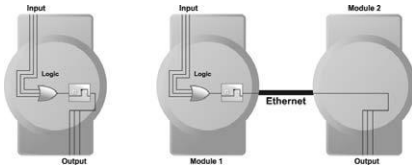

Cascade Logic

The output of one logic rule can be another rule. Therefore, different rules can be combined together. GCL provides this kind of functionality called Cascade Logic. It helps to create more input numbers of logic rule. For example, if users combine rule 1 and rule 2 with rule 3, the maximum inputs become seven. (Two inputs of rule 3 will be rule 1 and rule 2. Refer to figure below.) So users can define complex logic architecture to satisfy various application requirements.

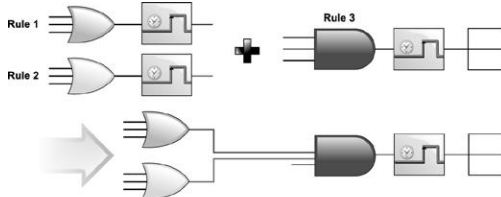

Distributed Cascade Logic

Users can assign other rule as output of one logic rule. In fact, that "Other Rule" can be on the same module, or on another remote module. So, one GCL logic architecture can operate across different modules. Several Ethernet I/O modules can be integrated into one complete logic system.

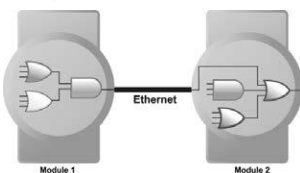

Feedback

Users can assign input and output of logic rule to the same internal register. This gives GCL feedback ability. No hardware wiring is needed.

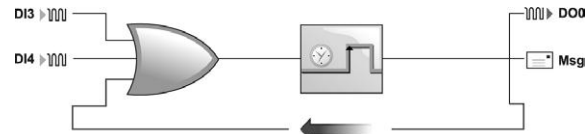

Rich I/O Options

Analog Input	Thermocouple, RTD, Voltage, Current
Analog Output	Voltage, Current
Digital Input	Dry Contact, Wet Contact, Counter/Frequency input
Digital Output	Sink, Source, Relay output, Pulse output

Fast Execution Time

Advantech GCL features extremely short logic rule execution time in the market. When users choose local output (input and output channel are on the same module), the processing time (including hardware input delay time, one logic rule execution time and hardware output delay time) is less than 1 millisecond. When users choose remote output (input and output channel are on different modules), the total time needed (including processing and communication time) is less than 3 milliseconds.

Analog Input Scaling

When configuring analog input condition, GCL provides linear scaling function to convert measured voltage/current value to its engineer unit value (such as temperature or pressure unit). Then users can use the engineer unit value to define the logic condition, and it is more intuitive for users.

Online Monitoring

After users complete all GCL configurations in ADAM.NET Utility, they can simply click the "Run Monitoring" button. Then users can see real-time execution workflow of logic rule on ADAM-6000 modules. Beside, current input values will also be displayed. This greatly helps users to maintain the system easily.

Sending Messages

In GCL, you can define your customized message. When conditions are satisfied, message, module's IP and I/O status will be sent to defined PC or device.

Local DO Status Can be Input Condition

In GCL, you can read the local DO channel value and use it in the input condition. So you can define logic rule based on the local DO status.

ADAM-6000 Features: Peer-to-Peer

Vertrieb durch **AMC**
AMC – Analytik & Messtechnik GmbH Chemnitz
 Heinrich-Lorenz-Str. 55 Tel.: +49/371/38388-0
 09120 Chemnitz Fax: +49/371/38388-99
 E-Mail: info@amc-systeme.de Web: www.amc-systeme.de

Requirements

One of our clients has three branches across multiple countries. For each branch, cameras were installed near the gates. At the headquarters, people in the control room can monitor each gate via the Intranet. Now they want to enhance the system to remotely control each gate, so that each gate can be controlled from inside the control room of the headquarters. Since the distance between the headquarters and each branch is thousands of miles away, it may be very difficult to establish extra communication network for this purpose.

Solution

Through three pairs of Advantech ADAM-6000 Peer-to-Peer Ethernet I/O modules (without any additional hardware), this application has been easily solved. For each pair of ADAM-6000 modules, one module is inside the headquarter's control room, and another is located at each branch. When the module in headquarters is activated, it will notify its paired module at the branch to open or close the gate. The communication is Ethernet-based, so that our clients can leverage their existing Ethernet infrastructure.

What is Peer-to-Peer?

Unlike client / server mode, Peer-to-Peer enabled modules will actively update input channel status to specific output channel. There will be a pair of module: one input module and one output module. Users can define the mapping between input channel and output channel. Then the input value will be transferred to the output channel actively.



What Benefits Do Peer-to-Peer Modules Provide?

No Controller Required

For Ethernet I/O modules without Peer-to-Peer functionality, a controller is needed to read data from the input module and then send data to the output module. With Peer-to-Peer solutions, the controller can be removed since data will automatically transfer. This not only simplifies the process, but also helps save system hardware costs.

No Programming Required

To utilize Peer-to-Peer modules, the only thing required is to configure related setting through ADAM .NET Utility. No additional programming effort is needed, that it helps to save system development time.

Simple and Flexible System Wiring

Long distance wiring can easily become a nightmare. For some automation applications, if the PLC and the sensors are far away, one remote I/O module needs to be located near the sensors, and a proprietary communication network needs to connect the PLC and the remote I/O module, and the communications distance is severely limited. Moreover, networks provided by PLC manufacturers are rarely open. Peer-to-Peer modules can replace limited and closed networks with no limitations since they leverage the most open and flexible Ethernet networks.

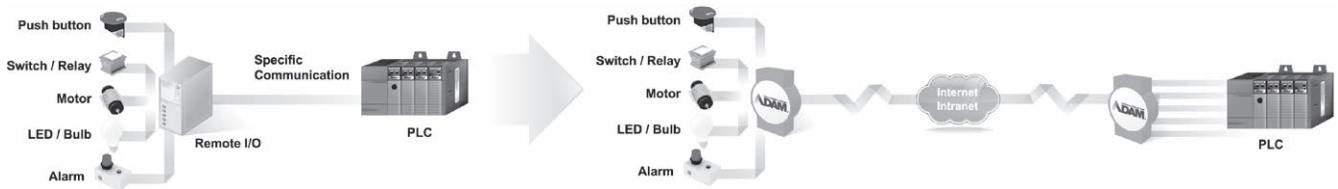

Why is Advantech's Peer-to-Peer Technology the Best Choice?

Flexible Channel Mapping

ADAM-6000 Peer-to-Peer modules provide two modes: Basic and Advanced. For Basic mode, channels on one input module are directly mapped to channels on another single output module. For Advanced mode, channels on one input module can be mapped to channels on different output modules. (Refer to figure below)

Fast Response Time

Advantech Peer-to-Peer modules feature excellent execution performance in market. The execution time to transfer data from input to output module is less than 1.2 millisecond.

Advanced Security

When engineers use Peer-to-Peer modules, they don't want it to be controlled by non-authorized computers or devices. ADAM-6000 Peer-to-Peer module lets users decide which IP or MAC address has control authority. This can make sure the output module is only controlled by its paired input module.

Advanced Reliability

When communication between a pair of ADAM-6000 Peer-to-Peer modules is broken, the digital output module can generate pre-defined value to ensure safety.

ADAM-6000 P2P Mode: Basic Mode

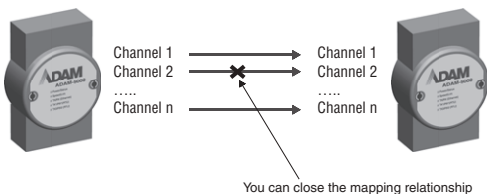

ADAM-6000 P2P Mode: Advanced Mode

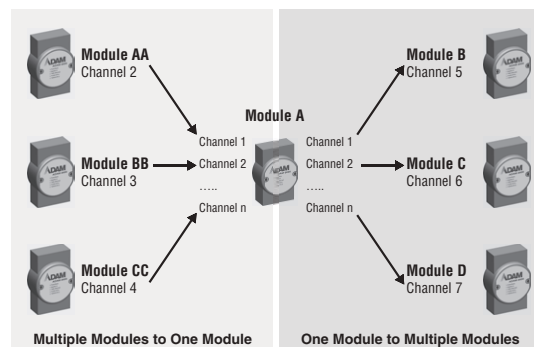

ADAM-6000 Series Selection Guide

Vertrieb durch 
AMC – Analytik & Messtechnik GmbH Chemnitz
 Heinrich-Lorenz-Str. 55 Tel.: +49/371/38388-0
 09120 Chemnitz Fax: +49/371/38388-99
 E-Mail: info@amc-systeme.de Web: www.amc-systeme.de



Spec.		Model	ADAM-6015	ADAM-6017	ADAM-6018	ADAM-6022	ADAM-6024
Interface			10/100 Mbps Ethernet				
Peer-to-Peer ¹				Yes		No	Receiver Only ²
GCL ¹				Yes		No	Receiver Only ²
Resolution				16 bit		16 bit for AI 12 bit for AO	16 bit for AI 12 bit for AO
Analog Input	Channels		7	8	8	6	6
	Sampling Rate				10 S/s		
	Voltage Input		-	±150 mV, ±500 mV, ±1 V, ±5 V, ±10 V	-	±10 V	±10 V
	Current Input		-	0 ~ 20 mA 4 ~ 20 mA	-	0 ~ 20 mA 4 ~ 20 mA	0 ~ 20 mA 4 ~ 20 mA
	Direct Sensor Input		Pt, Balco and Ni RTD	-	J, K, T, E, R, S, B Thermocouple	-	-
	Burn-out Detection		Yes	-	Yes	-	-
	Math. Functions		Max. Min. Avg.	Max. Min. Avg.	Max. Min. Avg.	-	-
Analog Output	Channels		-	-	-	2	2
	Current Output		-	-	-	0 ~ 20 mA, 4 ~ 20 mA with 15 V _{DC}	0 ~ 20 mA, 4 ~ 20 mA with 15 V _{DC}
	Voltage Output		-	-	-	0 ~ 10 V _{DC} with 30 mA	0 ~ 10 V _{DC} with 30 mA
Digital Input/Output	Input Channels		-	-	-	2	2
	Output Channels		-	2 (Sink)	8 (Sink)	2 (Sink)	2 (Sink)
	Extra Counter Channels		-	-	-	-	-
	Counter Input		-	-	-	-	-
	Frequency Input		-	-	-	-	-
	Pulse Output		-	-	-	-	-
	High/Low Alarm Settings		Yes	Yes	Yes	-	-
Isolation Protection				2,000 V _{DC}		2,000 V _{DC} ³	2,000 V _{DC} ³
Remark			-	-	-	Built-in Dual Loop PID Control Algorithm	-
Page			19-6	19-6	19-6	online	online



Spec.		Model	ADAM-6050	ADAM-6051	ADAM-6052	ADAM-6060	ADAM-6066
Interface			10/100 Mbps Ethernet				
Peer-to-Peer ¹					Yes		
GCL ¹					Yes		
Digital Input/Output	Input Channels		12	12	8	6	6
	Output Channels		6 (Sink)	2 (Sink)	8 (Source)	6-channel relay	6-channel power relay
	Extra Counter Channels		-	2	-	-	-
	Counter Input		3 kHz	4.5 kHz	3 kHz	3 kHz	3 kHz
	Frequency Input		3 kHz	4.5 kHz	3 kHz	3 kHz	3 kHz
	Pulse Output		-	-	Yes	-	-
	High/Low Alarm Settings		-	-	-	-	-
Isolation Protection					2,000 V _{DC}		
Page			19-7	19-7	19-7	19-8	19-8

Note 1: Peer-to-Peer and GCL cannot run simultaneously, only one feature is enabled at one time.

Note 2: ADAM-6024 can only act as a receiver and generate analog output when using Peer-to-Peer or GCL.

Note 3: Only for analog input and analog output channels.

ADAM-6015 ADAM-6017 ADAM-6018

7-ch Isolated RTD Input Modbus TCP Module
8-ch Isolated Analog Input Modbus TCP Module with 2-ch DO
8-ch Isolated Thermocouple Input Modbus TCP Module with 8-ch DO



ADAM-6015 FCC CE RoHS UL US



ADAM-6017 FCC CE RoHS UL US



ADAM-6018 FCC CE RoHS UL US

AAC ADVANTECH Premier Partner

Specifications

Analog Input

- **Channels** 7 (differential)
- **Input Impedance** > 10 MΩ
- **Input Connections** 2 or 3 wire
- **Input Type** Pt, Balco and Ni RTD
- **RTD Types and Temperature Ranges**
 - Pt 100 -50°C ~ 150°C
 - 0°C ~ 100°C
 - 0°C ~ 200°C
 - 0°C ~ 400°C
 - 200°C ~ 200°C
 - Pt 1000 -40°C ~ 160°C
- Supports both IEC 60751 ITS90 (0.03851 W/W/°C) and JIS C 1604 (0.03916 W/W/°C)
- Balco 500 -30°C ~ 120°C
- Ni 518 -80°C ~ 100°C
- 0°C ~ 100°C
- **Accuracy** ± 0.1 %
- **Span Drift** ± 25 ppm/°C
- **Zero Drift** ± 6 μV/°C
- **Wire Burn-out Detection**

Ordering Information

- **ADAM-6015** 7-ch Isolated RTD Input Modbus TCP Module

Specifications

Analog Input

- **Channels** 8 (differential)
- **Input Impedance** > 10 MΩ (voltage)
120 Ω (current)
- **Input Type** mV, V, mA
- **Input Range** ±150 mV, ±500 mV, ±1 V
±5 V, ±10 V, 0-20 mA, 4-20 mA
- **Accuracy** ±0.1% (voltage)
±0.2% (current)
- **Span Drift** ±25 ppm/°C
- **Zero Drift** ±6 μV/°C

Digital Output

- **Channels** 2, open collector to 30 V, 100 mA max. load
- **Power Dissipation** 300 mW for each module

Ordering Information

- **ADAM-6017** 8-ch Isolated AI with 2-ch DO Modbus TCP Module

Specifications

Analog Input

- **Channels** 8 (differential)
- **Input Impedance** > 10 MΩ
- **Input Type** Thermocouple
- **Thermocouple Type and Range:**

J	0 ~ 760°C	R	500 ~ 1,750°C
K	0 ~ 1,370°C	S	500 ~ 1,750°C
T	-100 ~ 400°C	B	500 ~ 1,800°C
E	0 ~ 1,000°C		

- **Accuracy** ±0.1%
- **Span Drift** ±25 ppm/°C
- **Zero Drift** ±6 μV/°C
- **Wire Burn-out Detection**

Digital Output

- **Channels** 8, open collector to 30 V, 100 mA max. load
- **Power Dissipation** 300 mW for each module

Ordering Information

- **ADAM-6018** 8-ch Isolated Thermocouple Input Modbus TCP Module w/ 8-ch DO

Vertrieb durch **AAC**

AMC – Analytik & Messtechnik GmbH Chemnitz

Heinrich-Lorenz-Str. 55 Tel.: +49/371/38388-0
09120 Chemnitz Fax: +49/371/38388-99
E-Mail: info@amc-systeme.de Web: www.amc-systeme.de

Common Specifications

General

- **LAN** 10/100Base-T(X)
- **Power Consumption** 2 W @ 24 V_{DC}
- **Connectors** 1 x RJ-45 (LAN), Plug-in screw terminal block (I/O and power)
- **Watchdog** System (1.6 second) and Communication (programmable)
- **Power Input** 10 ~ 30 V_{DC}
- **Supports Peer-to-Peer**

- **Supports GCL**
- **Supports Modbus/TCP, TCP/IP, UDP and HTTP Protocols**

Analog Input

- **Resolution** 16-bit
- **Sampling Rate** 10 sample/second (total)
- **CMR @ 50/60 Hz** 90 dB
- **NMR @ 50/60 Hz** 90 dB

Protection

- **Over Voltage Protection** ±35 V_{DC}
- **Isolation Protection** 2,000 V_{DC}

- **Built-in TVS/ESD Protection**
- **Power Reversal Protection**

Environment

- **Operating Temperature** -10 ~ 70°C (14 ~ 158°F)
- **Storage Temperature** -20 ~ 80°C (-4 ~ 176°F)
- **Operating Humidity** 20 ~ 95% RH (non-condensing)
- **Storage Humidity** 0 ~ 95% RH (non-condensing)

ADAM-6050

ADAM-6051

ADAM-6052

18-ch Isolated Digital I/O Modbus TCP Module
14-ch Isolated Digital I/O Modbus TCP Module with 2-ch Counter
16-ch Source-type Isolated Digital I/O Modbus TCP Module



ADAM-6050

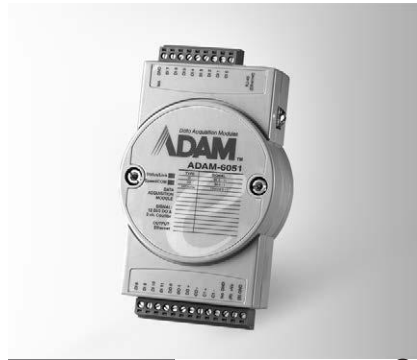

ADAM-6051



ADAM-6052



Specifications

Digital Input

- **Channels** 12
- **Dry Contact** Logic level 0: close to GND
Logic level 1: open
- **Wet Contact** Logic level 0: 0 ~ 3 V_{DC}
Logic level 1: 10 ~ 30 V_{DC}
- Supports 3 kHz Counter Input (32-bit + 1-bit overflow)
- Keep/Discard Counter Value when Power-off
- Supports 3 kHz Frequency Input
- Supports Inverted DI Status

Digital Output

- **Channels** 6 (sink type), open collector to 30 V, 100 mA maximum load
- Supports 5 kHz Pulse Output
- Supports High-to-Low and Low-to-High Delay Output

Ordering Information

- **ADAM-6050** 18-ch Isolated DI/O Modbus TCP Module

Specifications

Digital Input

- **Channels** 12
- **Dry Contact** Logic level 0: close to GND
Logic level 1: open
- **Wet Contact** Logic level 0: 0 ~ 3 V_{DC}
Logic level 1: 10 ~ 30 V_{DC}
- Supports 3 kHz Counter Input (32-bit + 1-bit overflow)
- Keep/Discard Counter Value when Power-off
- Supports 3 kHz Frequency Input
- Supports Inverted DI Status

Counter Input

- **Channels** 2
- **Mode** Counter, Frequency
- **Keep/Discard Counter Value when Power-off** 4,294,967,295 (32-bit + 1-bit overflow)
- **Maximum Count** 4,294,967,295 (32-bit + 1-bit overflow)
- **Input Frequency** Frequency Mode: 0.2 ~ 4500 Hz
Counter Mode: 0 ~ 4.5 kHz

Digital Output

- **Channels** 2 (sink type), open collector to 30 V, 100 mA maximum load
- Supports 5 kHz Pulse Output
- Supports High-to-Low and Low-to-High Delay Output

Ordering Information

- **ADAM-6051** 14-ch Isolated DI/O with Counter Modbus TCP Module

Specifications

Digital Input

- **Channels** 8
- **Dry Contact** Logic level 0: close to GND
Logic level 1: open
- **Wet Contact** Logic level 0: 0 ~ 3 V_{DC}
Logic level 1: 10 ~ 30 V_{DC}
- Supports 3 kHz Counter Input (32-bit + 1-bit overflow)
- Keep/Discard Counter Value when Power-off
- Supports 3 kHz Frequency Input
- Supports Inverted DI Status

Digital Output

- **Channels** 8 (Source Type)
- **Voltage Range** 10 ~ 35 V_{DC}
- **Current** 1 A (per channel)
- Supports 5 kHz Pulse Output
- Supports High-to-Low and Low-to-High Delay Output
- Supports Over Current Protection

Ordering Information

- **ADAM-6052** 16-ch Source-type Isolated DI/O Modbus TCP Module

Vertrieb durch 

AMC – Analytik & Messtechnik GmbH Chemnitz
 Heinrich-Lorenz-Str. 55 Tel.: +49/371/38388-0
 09120 Chemnitz Fax: +49/371/38388-99
 E-Mail: info@amc-systeme.de Web: www.amc-systeme.de

Common Specifications

General

- **LAN** 10/100Base-T(X)
- **Power Consumption** 2 W @ 24 V_{DC}
- **Connectors** 1 x RJ-45 (LAN), Plug-in screw terminal block (I/O and power)
- **Watchdog** System (1.6 second) and Communication (programmable)

- **Power Input** 10 ~ 30 V_{DC}
- Supports Peer-to-Peer
- Supports GCL
- Supports Modbus/TCP, TCP/IP, UDP and HTTP Protocol

Protection

- **Power Reversal Protection**
- **Isolation Protection** 2,000 V_{DC}

Environment

- **Operating Temperature** -10 ~ 70°C (14 ~ 158°F)
- **Storage Temperature** -20 ~ 80°C (-4 ~ 176°F)
- **Operating Humidity** 20 ~ 95% RH (non-condensing)
- **Storage Humidity** 0 ~ 95% RH (non-condensing)

ADAM-6060

ADAM-6066

**6-ch Digital Input and 6-ch Relay
Modbus TCP Module**

**6-ch Digital Input and 6-ch Power Relay
Modbus TCP Module**



ADAM-6060

ADAM-6066



Specifications

General

- LAN 10/100Base-T(X)
- Power Consumption 2 W @ 24 V_{DC} (ADAM-6060)
2.5 W @ 24 V_{DC} (ADAM-6066)
- Connectors 1 x RJ-45 (LAN), Plug-in screw terminal block (I/O and power)
- Watchdog Timer System (1.6 second) and Communication (programmable)
- Power Input 10 ~ 30 V_{DC}
- Supports Peer-to-Peer
- Supports GCL
- Supports Modbus/TCP, TCP/IP, UDP and HTTP Protocols

Digital Input

- Channels 6
- Dry Contact Logic level 0: close to GND
Logic level 1: open
- Wet Contact Logic level 0: 3 V_{DC}
Logic level 1: 10 ~ 30 V_{DC}
- Supports 3 kHz Counter Input (32-bit + 1-bit overflow)
- Keep/Discard Counter Value when Power-off
- Supports 3 kHz Frequency Input
- Supports Inverted DI Status

Relay Output (Form A)

- Channels 6
- Contact Rating (Resistive) ADAM-6060: 120 V_{AC} @ 0.5 A
30 V_{DC} @ 1 A
ADAM-6066: 250 V_{AC} @ 5 A
30 V_{DC} @ 3 A
- Breakdown Voltage 500 V_{AC} (50/60 Hz)
- Relay On Time 7 ms
- Relay Off Time 3 ms
- Total Switching Time 10 ms
- Insulation Resistance 1 GΩ min. at 500 V_{DC}
- Maximum Switching Rate (at rated load) 20 operations/minute
- Supports Pulse Output

Protection

- Isolation Voltage 2,000 V_{DC}
- Power Reversal Protection

Environment

- Operating Temperature 10 ~ 70°C (50 ~ 158°F)
- Storage Temperature -20 ~ 80°C (-4 ~ 176°F)
- Operating Humidity 20 ~ 95% RH (non-condensing)
- Storage Humidity 0 ~ 95% RH (non-condensing)

Ordering Information

- ADAM-6060 6-ch DI and 6-ch Relay Modbus TCP Module
- ADAM-6066 6-ch DI and 6-ch Power Relay Modbus TCP Module

ADAM-6000 Series Dimensions

Unit: mm

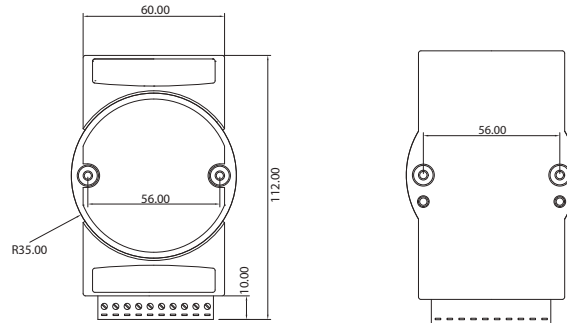

Front View

Rear View

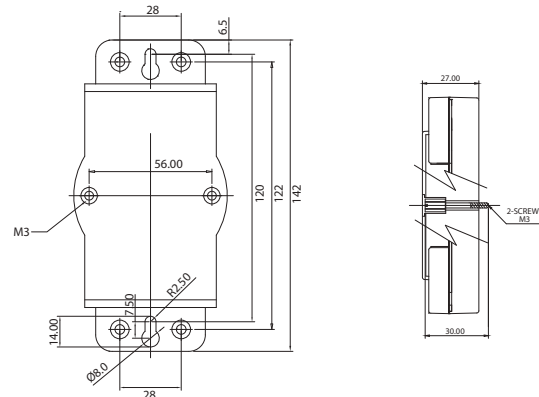

Wall Mounting View

Side View

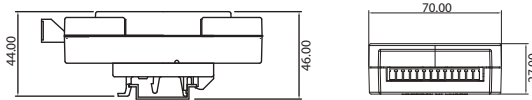

DIN-Rail Mounting View

Top View

ADAM-6000 Series Common Specifications

General

- Dimension (W x H x D) 70 x 120 x 30 mm
- Enclosure ABS+PC
- Mounting DIN 35 rail, stack, wall

Vertrieb durch



AMC – Analytik & Messtechnik GmbH Chemnitz

Heinrich-Lorenz-Str. 55 Tel.: +49/371/38388-0
09120 Chemnitz Fax: +49/371/38388-99
E-Mail: info@amc-systeme.de Web: www.amc-systeme.de

EtherNet/IP & PROFINET I/O Module Introduction



Real-time distributed control systems are an important technology for reliable industrial Ethernet and automation applications. A number of techniques are used to adapt the Ethernet protocol for industrial processes, which must provide reliable service to ensure stable operation. Through modern protocols, automation systems from different manufacturers can be interconnected throughout a plant. Industrial Ethernet takes advantage of the relatively larger marketplace for computer interconnections to reduce cost and improve performance of communications between industrial controllers.

Vertrieb durch **AAC**

AMC – Analytik & Messtechnik GmbH Chemnitz

Heinrich-Lorenz-Str. 55 Tel.: +49/371/38388-0
 09120 Chemnitz Fax: +49/371/38388-99
 E-Mail: info@amc-systeme.de Web: www.amc-systeme.de

19
Ethernet I/O Modules

20
DAQ Boards

21
Signal Conditioning

22
Industrial USB I/O Modules

Real-time Systems

A real-time system is one in which the correctness of a result not only depends on correct calculations, but also upon correct timing.

In computing, real-time refers to a time frame that is very brief, appearing to be immediate. When a computer processes data in real time, it reads and handles data as it is received, producing results without delay. A non real-time computer process does not have a deadline. Such a process can be considered non-real-time, even if fast results are preferred. A real-time system, on the other hand, is expected to respond not just quickly, but also within a predictable period of time. In an automation control system, real time technology provides multiple advantages, such as improved safety, quality, and efficiency.

To build a real-time distributed control system, it is critical to establish reliable and real-time communication among the controllers and targets. Distributed processors must be able to intercommunicate via real-time protocols. There is now increasing interest in the use of Ethernet as the link-layer protocol, such as EtherNet/IP, PROFINET, EtherCAT, Ethernet PowerLink, SERCOS III.

EtherNet/IP

EtherNet/IP was developed in the late 1990's by Rockwell Automation for use in process control and other industrial automation applications, ensuring multi-vendor system interoperability. EtherNet/IP is a lot like standard office Ethernet, using the same TCP/IP messaging but with a new application layer added where data is arranged. This is known as Object-Orientated Organization, and allows ordinary office Ethernet to become a more versatile system. Today, EtherNet/IP is commonly used in industrial automation applications, such as water processing, manufacturing, and utilities.

PROFINET

PROFINET is the open industrial Ethernet standard of PROFIBUS & PROFINET International (PI) for automation. Like EtherNet/IP, it uses TCP/IP standards as protocols for communication in the network. It includes two modes - PROFINET IO and PROFINET CBA - and allows to combine distributed automation and distributed I/O. With its flexible capabilities, PROFINET is suitable for most automation technology requirements.

Feature Highlights

Daisy Chain Connections

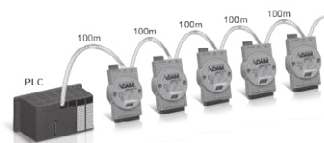

Each ADAM-6100 module has two built in Ethernet switches to allow daisy chain connections in an Ethernet network, making it easier to deploy, helping improve scalability and improving resistance against interference common in factory settings.

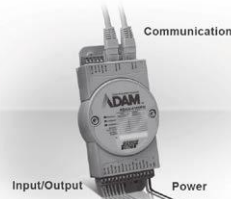

2,500 V_{DC} Isolation Protection

With triple isolation, including power supply, input/output, and Ethernet communication, ADAM-6100 series ensures I/O data to be controlled correctly, and prevents devices from breaking down.

Ethernet-based Configuration Tool

ADAM.NET Utility comes bundled with each ADAM-6100 module. With ADAM.NET Utility, users can configure, set and test ADAM-6100 modules through Ethernet.

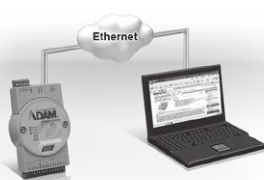

Multiple Mounting Mechanisms

Advantech provides versatile mounting methods to fit various demands in the field. ADAM-6100 series supports DIN-rail mounting, wall mounting and piggybacking.

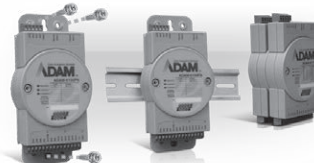

ADAM-6100 Series Selection Guide

Vertrieb durch



AMC – Analytik & Messtechnik GmbH Chemnitz

Heinrich-Lorenz-Str. 55 Tel.: +49/371/38388-0

09120 Chemnitz Fax: +49/371/38388-99

E-Mail: info@amc-systeme.de Web: www.amc-systeme.de

NEW



NEW



Model	ADAM-6117	ADAM-6124	ADAM-6150	ADAM-6151	ADAM-6156	ADAM-6160	
Interface	10/100 Mbps Ethernet						
Support Protocol	ADAM-6100EI: EtherNet/IP; ADAM-6100PN: PROFINET						
Analog Input	Resolution	16-bit	-	-	-	-	
	Channels	8	-	-	-	-	
	Sampling Rate (sample/second)	10	-	-	-	-	
	Voltage Input	±150 mV ±500 mV ±1 V ±5 V ±10 V	-	-	-	-	-
	Current Input	0 ~ 20 mA 4 ~ 20 mA ±20 mA	-	-	-	-	-
	Direct Sensor Input	-	-	-	-	-	-
Analog Output	Resolution	-	12-bit	-	-	-	
	Channels	-	4	-	-	-	
	Current Output	-	0~20 mA, 4~20 mA	-	-	-	
	Voltage Output	-	0 ~ 5 V, 0 ~ 10 V, ±5 V, ±10 V	-	-	-	
Digital Input/Output	Input Channels	-	4 (Dry Contact Only)	8	16	-	
	Output Channels	-	-	7	-	16 6-ch power relay	
Isolation Protection	2,500 V _{DC}	2,500 V _{DC}	2,500 V _{DC}	2,500 V _{DC}	2,500 V _{DC}	2,500 V _{DC}	
Connectors	2 x RJ-45 LAN (Daisy Chain) Plug-in screw terminal block (I/O and power)						
Page	19-11	19-11	19-12	19-12	19-12	19-12	



ADVANTECH
Premier Partner

ADAM-6117

ADAM-6124

8-ch Isolated Analog Input Real-time Ethernet Module

4-ch Analog Output Real-time Ethernet Module

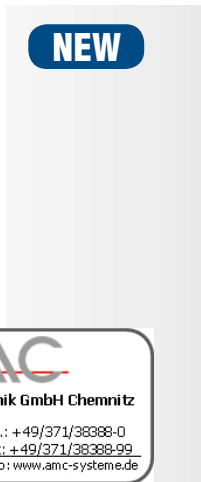
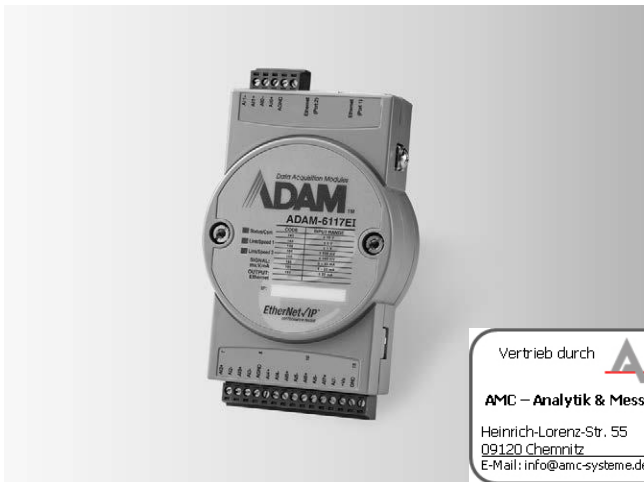

ADVANTECH
Premier Partner



Vertrieb durch **AAC**
AMC – Analytik & Messtechnik GmbH Chemnitz
 Heinrich-Lorenz-Str. 55 Tel.: +49/371/38388-0
 09120 Chemnitz Fax: +49/371/38388-99
 E-Mail: info@amc-systeme.de Web: www.amc-systeme.de

ADAM-6117



ADAM-6124



Specifications

Analog Input

- **Channels** 8 (differential)
- **Input Impedance** > 10 MΩ (voltage)
120 Ω (current)
- **Input Type** mV, V, mA
- **Input Range** ±150 mV, ±500 mV, ±1 V
±5 V, ±10 V, 0~20 mA,
4~20 mA, ±20 mA
- **Span Drift** ± 30 ppm/°C
- **Zero Drift** ± 6 μV/°C
- **Resolution** 16-bit
- **Accuracy** ± 0.1% of FSR (Current) at 25°C
± 0.2% of FSR (Current) at 25°C
- **Sampling Rate** 10 sample/second (total)
- **CMR @ 50/60 Hz** 92 dB
- **NMR @ 50/60 Hz** 60 dB
- **High Common Mode** 200 V_{DC}

Ordering Information

- **ADAM-6117E1** 8-ch Isolated AI EtherNet/IP Module
- **ADAM-6117PN** 8-ch Isolated AI PROFINET Module

Specifications

Analog Output

- **Channels** 4
- **Output Impedance** 2.1 Ω
- **Output Settling Time** 20 μs
- **Driving Load** Voltage: 2kΩ
Current: 500 Ω
- **Programmable Output Slope** 0.125 ~ 128 mA/sec
0.0625 ~ 64 V/sec
- **Output Type** V, mA
- **Output Range** 0 ~ 5 V, 0 ~ 10 V, ± 5 V, ± 10 V
0 ~ 20 mA, 4 ~ 20 mA
- **Accuracy** 0.3% of FSR (Voltage) at 25°C
0.5% of FSR (Current) at 25°C
- **Resolution** 12-bit
- **Current Load Resistor** 0 ~ 500 Ω
- **Drift** ± 50 ppm/°C

Digital Input

- **Channels** 4 (Dry Contact only)
- **Dry Contact** Logic 0: Open
Logic 1: Closed to DGND

Ordering Information

- **ADAM-6124E1** 4-ch Isolated Analog Output EtherNet/IP Module
- **ADAM-6124PN** 4-ch Isolated Analog Output PROFINET Module

Common Specifications

General

- **LAN** 10/100Base-T(X)
- **Power Consumption** ADAM-6117: 3.5 W @ 24 V_{DC}
ADAM-6124: 6 W @ 24 V_{DC}
- **Connectors** 2 x RJ-45 LAN (Daisy Chain)
Plug-in screw terminal block (I/O and power)
- **Watchdog** System (1.6 second)
- **Power Input** 10 ~ 30 V_{DC}

Protection

- **Isolation Protection** 2,500 V_{DC}
- **Built in TVS/ESD Protection**
- **Power Reversal Protection**

Environment

- **Operating Temperature** -10 ~ 70°C (14 ~ 158°F)
- **Storage Temperature** -20 ~ 80°C (-4 ~ 176°F)
- **Operating Humidity** 20 ~ 95% RH (non-condensing)
- **Storage Humidity** 0 ~ 95% RH (non-condensing)

ADAM-6150 ADAM-6151/6156 ADAM-6160

15-ch Isolated Digital I/O Real-time Ethernet Module

16-ch Isolated Digital Input/ Digital Output Real-time Ethernet Module

6-ch Relay Real-time Ethernet Module



ADAM-6150/6151/6156

FCC CE RoHS COMPLIANT 2002/95/EC

Specifications

Digital Input

- **Channels** ADAM-6150: 8
ADAM-6151: 16
- **Dry Contact** Logic level 0: open
Logic level 1: close to DGND
- **Wet Contact** Logic level 0: 0 ~ 3 V_{DC} or 0 ~ -3 V_{DC}
Logic level 1: 10 ~ 30 V_{DC} or -10 ~ -30 V_{DC}
(Dry/Wet Contact decided by switch)
- **Input Impedance** 5.2 kΩ (Wet Contact)
- **Transition Time** From logic level 0 to 1: 0.2 ms
From logic level 1 to 0: 0.2 ms

Digital Output

- **Channels** ADAM-6150: 7
ADAM-6156: 16
- **Output Voltage Range** 8 ~ 35 V_{DC}
- **Normal Output Current** 100 mA (per channel)

Ordering Information

- **ADAM-6150EI** 15-ch Isolated DI/O EtherNet/IP Module
- **ADAM-6151EI** 16-ch Isolated DI EtherNet/IP Module
- **ADAM-6156EI** 16-ch Isolated DO EtherNet/IP Module
- **ADAM-6150PN** 15-ch Isolated DI/O PROFINET Module
- **ADAM-6151PN** 16-ch Isolated DI PROFINET Module
- **ADAM-6156PN** 16-ch Isolated DO PROFINET Module

Common Specifications

General

- **LAN** 10/100Base-T(X)
- **Power Consumption** ADAM-6150: 3 W @ 24 V_{DC}
ADAM-6151: 2.7 W @ 24 V_{DC}
ADAM-6156: 3.2 W @ 24 V_{DC}
ADAM-6160: 4.5 W @ 24 V_{DC}
- **Connectors** 2 x RJ-45 LAN, (Daisy Chain)
Plug-in screw terminal block (I/O and power)
- **Watchdog** System (1.6 second)
- **Power Input** 10 ~ 30 V_{DC}

Protection

- **Over Voltage Protection** ±35 V_{DC}
- **Isolation Protection** 2,500 V_{DC}
- **Power Reversal Protection**

Environment

- **Operating Temperature** -10 ~ 70°C (14 ~ 158°F)
- **Storage Temperature** -20 ~ 80°C (-4 ~ 176°F)
- **Operating Humidity** 20 ~ 95% RH (non-condensing)
- **Storage Humidity** 0 ~ 95% RH (non-condensing)
0 ~ 95% RH (non-condensing)



ADVANTECH
Premier Partner



ADAM-6160

FCC CE RoHS COMPLIANT 2002/95/EC

Specifications

Relay Output

- **Channels** 5 Form C and 1 Form A
- **Contact Rating** 250 V_{AC} @ 5A
30 V_{DC} @ 5A
- **Max. Switching Voltage** 400 V_{AC}
300 V_{DC}
- **Breakdown Voltage** 500 V_{AC} (50/60Hz)
- **Max. Breakdown Capacity** 1250 VA
- **Frequency of Operation** 360 operations/hour with load
72,000 operations/hour without load
- **Set/Reset Time** 8 ms/8 ms
- **Mechanical Endurance** > 15 x 10⁶ operations
- **Isolation between Contact** 1000 V_{ms}
- **Insulation Resistance** > 10 GΩ @ 500 V_{DC}

Ordering Information

- **ADAM-6160EI** 6-ch Relay EtherNet/IP Module
- **ADAM-6160PN** 6-ch Relay PROFINET Module

Vertrieb durch



AMC – Analytik & Messtechnik GmbH Chemnitz

Heinrich-Lorenz-Str. 55 Tel.: +49/371/38388-0
09120 Chemnitz Fax: +49/371/38388-99
E-Mail: info@amc-systeme.de Web: www.amc-systeme.de

ADAM-6200 Series

Vertrieb durch **AAC**

AMC – Analytik & Messtechnik GmbH Chemnitz

Heinrich-Lorenz-Str. 55 Tel.: +49/371/38388-0
 09120 Chemnitz Fax: +49/371/38388-99
 E-Mail: info@amc-systeme.de Web: www.amc-systeme.de



Feature

- Daisy chain connection with auto-bypass protection
- Remote monitoring and control with smart phone/pad
- Group configuration capability for multiple module setup
- DI/O LED Indication
- Flexible user-defined Modbus address
- Intelligent control ability by Peer-to-Peer and GCL function
- Multiple protocol support: Modbus TCP, TCP/IP, UDP, HTTP, DHCP
- Web language support: XML, HTML 5, Java Script
- System configuration backup
- User Access Control

Transition and Vision on Remote DAQ Device

In 2002, Advantech released its first Ethernet I/O module, ADAM-6000 series, which aims to provide ideal remote Ethernet I/O solution for industrial automation environments. It could work as a standalone station to conduct data acquisition, processing and delivery reliably in diverse of automation applications such as factory automation, EFMS and building automation.

However, as of today, the information technologies and network infrastructure are getting well-developed in the world. More and more enterprises not only face the requirement of enhancing their existing automation systems for greater overall equipment effectiveness (OEE), but also need up-to-date information integration, plant management and business systems. In the same way, the remote DAQ modules should be evolved to make it more effective, interoperable, and smarter than before to meet new requirements.

In the future, there are plenty of potential key elements like intelligence, energy-efficiency, cloud computing, cyber-security and mobile communication technologies being progressively leveraged in automation market. We believe that these will also contribute to ideal remote DAQ devices in IoT world.

In order to fulfill the transition of requirements and future applications, Advantech releases ADAM-6200 series, a new selection of Ethernet I/O family comprised of analog I/O, digital I/O and relay modules. ADAM-6200 series module possesses plenty of advanced features whatever the evolution of hardware design and what's worth expecting for user is a variety of useful software functions to make it effective in the application field. With new design and strong capabilities, ADAM-6200 can be a well-integrated I/O solution in Ethernet control system.



ADVANTECH
Premier Partner

19
Ethernet I/O Modules

20
DAQ Boards

21
Signal Conditioning

22
Industrial USB I/O Modules

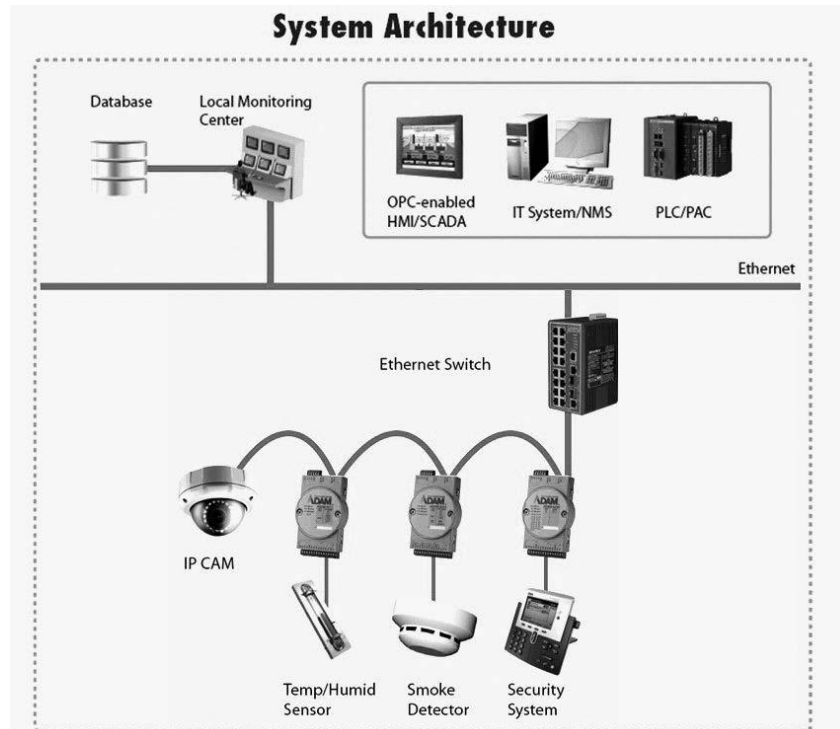

ADAM-6200 Key Features

Flexible Deployment with Daisy Chain Networking and Auto-Bypass Protection

ADAM-6200 module has built-in Ethernet switches to allow daisy chain connections in an Ethernet network, making it easier to deploy, saving wiring costs, and helping improve scalability. The two Ethernet ports are fully compliant with IEEE 802.3u 10/100Mbps through standard RJ-45 connectors.

Although daisy chain topology brings attractive benefits for user, it still comes with the risk that once any device in the daisy-chain network suffers power outage, it will cause the disconnection of all devices data stream

Auto-bypass Protection

To prevent this critical issue from happening, Advantech especially refines the hardware design of ADAM-6200 so that it can rapidly recover the network connection in about 2.5 seconds. Therefore, the damage will be greatly minimized.



Remote Monitoring and Control with Smart Phone/Pad

In early stage of automation, it's hard to access or obtain the data of equipments online when conducting on-site inspection. Mostly, the possible way to do that is communicating with engineers in branch or central control room where the SCADA program is running. It always takes extra efforts to complete an on-site checking or debugging.

The ADAM-6200 series module integrates the latest Web language HTML 5, allowing users to remotely monitor the status of all online modules without bridging SCADA system and to perform basic I/O configurations on any built-in HMI devices such as Smart Phone, Smart Pad over the Internet. Moreover, users can further develop its extended applications based on the default HTML 5 file embedded in the module.

HTML 5

HTML is a markup language popularly used to program the content for Web page over the Internet. The fifth revision (HTML 5) is the latest revision which enhances its syntax structure and additionally mixes up with rich Web technologies like CSS, Java Script to implement more Web service, API, interactive applications in mobile communications.

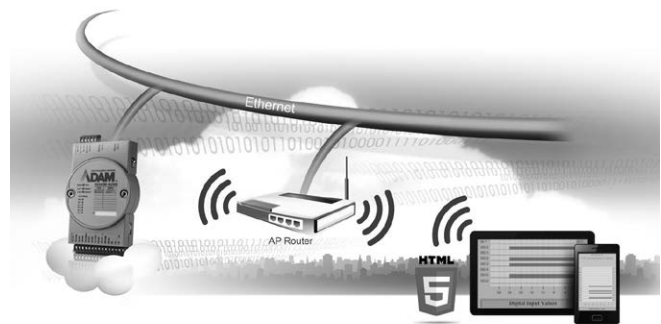

Group Configuration Capability for Multiple Module Setup

In certain application scenario, it requires to set multiple modules with the same settings because these modules are doing the same tasks on different sites. Users have to set configurations of module one after another before onsite deployment. After the modules are installed and the system is running, it will still require repetitive efforts in maintenance when doing firmware update.

ADAM-6200 series module is equipped with group configuration capability to reduce the repetitive efforts and quickly finish the multiple module setups, including firmware upgrade, configuration and HTML 5 file at one time. Users can finish the module installation faster than before as the configuration time tremendously reduced.



ADAM-6200 Series Selection Guide

Vertrieb durch



AMC – Analytik & Messtechnik GmbH Chemnitz

Heinrich-Lorenz-Str. 55 Tel.: +49/371/38388-0
 09120 Chemnitz Fax: +49/371/38388-99
 E-Mail: info@amc-systeme.de Web: www.amc-systeme.de

NEW



NEW



NEW



NEW



NEW



NEW



NEW



NEW



Model	ADAM-6217	ADAM-6218	ADAM-6224	ADAM-6250	ADAM-6251	ADAM-6256	ADAM-6260	ADAM-6266	
Interface	10/100Mbps Ethernet								
Analog Input	Channels	8	6	-	-	-	-	-	
	Input Impedance	>10MΩ (voltage) 120 Ω (current)	>1MΩ (voltage) 120 Ω (current)	-	-	-	-	-	
	Voltage Input	± 150mV, ± 500mV, ± 1V, ± 5V, ± 10V	± 50mV, ± 100mV, ± 500mV, ± 1V, ± 2.5V	-	-	-	-	-	
	Current Input	0 ~ 20 mA, 4 ~ 20mA, ± 20mA	0 ~ 20mA, 4 ~ 20mA, ± 20mA	-	-	-	-	-	
	Sampling Rate (sample/second)	10	10	-	-	-	-	-	
	Direct Sensor Input	-	J, K, T, E, R, S, B Thermocouple	-	-	-	-	-	
	Burn-out Detection	Yes (4~20 mA)	Yes (TC, 4~20 mA)	-	-	-	-	-	
	Resolution	16-bit	16-bit	-	-	-	-	-	
	Accuracy	± 0.1% of FSR (Voltage) at 25°C ± 0.2% of FSR (Current) at 25°C		-	-	-	-	-	
Analog Output	Channels	-	-	4	-	-	-	-	
	Voltage Output	-	-	0 ~ 5V, 0 ~ 10V, ± 5V, ± 10V	-	-	-	-	
	Current Output	-	-	0 ~ 20mA, 4 ~ 20mA	-	-	-	-	
	Resolution	-	-	12-bit	-	-	-	-	
Digital Input/Output	Input Channels	-	-	4 (Dry contact only)	8	16	-	4	
	Output Channels	-	-	-	7 (Sink)	-	16 (Sink)	-	
	Relay Output	-	-	-	-	-	-	6 (5 Form C + 1 Form A) 4 (Form C)	
	Contact Rating	-	-	-	-	-	-	250 V _{ac} @ 5A 30 V _{dc} @ 5A	
	Counter Input	-	-	-	3kHz	3kHz	-	-	3kHz
	Frequency Input	-	-	-	3kHz	3kHz	-	-	3kHz
	Pulse Output	-	-	-	5kHz	-	5kHz	5kHz	5kHz
LED Indicator	-	-	-	8 DI, 7 DO	16 DI	16 DO	6 RL	4 DI, 4 RL	
Power Consumption	3.5W	3.5W	6W	3W	2.7W	3.2W	4.5W	4.2W	
Isolation Voltage	2,500 V _{dc}								
Watchdog Timer	System (1.6 seconds) Communication (Programmable)								
Communication Protocol	Modbus TCP, TCP/IP, UDP, HTTP, DHCP								
Power Requirement	10 - 30 V _{dc} (24 V _{dc} standard)								
Operation Temperature	-10 ~ 70°C (14 ~ 158°F)								
Storage Temperature	-20 ~ 80°C (-4 ~ 176°F)								
Operating Humidity	20 ~ 95% RH (non-condensing)								
Storage Humidity	0 ~ 95% RH (non-condensing)								
Page	19-16	19-16	19-16	19-17	19-17	19-17	19-18	19-18	

19
Ethernet I/O Modules

20
DAQ Boards

21
Signal Conditioning

22
Industrial USB I/O Modules



ADVANTECH
Premier Partner

ADAM-6217

ADAM-6218

ADAM-6224

8-ch Isolated Analog Input Modbus TCP Module

6-ch Thermocouple Input Modbus TCP Module

4-ch Isolated Analog Output Modbus TCP Module



Specifications

Analog Input

- **Channels** 8 (differential)
- **Input Impedance** > 10 MΩ (voltage)
120 Ω (current)
- **Input Type** mV, V, mA
- **Input Range** ±150 mV, ±500 mV, ±1 V, ±5 V, ±10 V, 0~20 mA, 4~20 mA, ±20 mA
- **Span Drift** ± 30 ppm/°C
- **Zero Drift** ± 6 μV/°C
- **Resolution** 16-bit
- **Accuracy** ± 0.1% of FSR (Voltage) at 25°C
± 0.2% of FSR (Current) at 25°C
- **Sampling Rate** 10 sample/second (total)
- **CMR @ 50/60 Hz** 92 dB
- **NMR @ 50/60 Hz** 60 dB
- **Common Mode** 200 V_{DC}

Ordering Information

- **ADAM-6217** 8-ch Isolated Analog Input Modbus TCP Module

Vertrieb durch 

AAC – Analytik & Messtechnik GmbH Chemnitz

Heinrich-Lorenz-Str. 55 Tel.: +49/371/38388-0
09120 Chemnitz Fax: +49/371/38388-99
E-Mail: info@aac-systeme.de Web: www.aac-systeme.de

Specifications

Analog Input

- **Channels** 6 (differential)
- **Input Impedance** > 1 MΩ (voltage)
120 Ω (current)
- **Input Type** mV, V, mA, Thermocouple
- **Temperature Range**

J	-210 ~ 1,200°C	R	0 ~ 1,768°C
K	-270 ~ 1,372°C	S	0 ~ 1,768°C
T	-270 ~ 400°C	B	200 ~ 1,820°C
E	-270 ~ 1,000°C		
- **Voltage/Current Input Range** ±50 mV, ±100 mV, ±500 mV, ±1 V, ±2.5 V, ±20 mA, 0~20 mA, 4~20 mA
- **Span Drift** ± 30 ppm/°C
- **Zero Drift** ± 6 μV/°C
- **Resolution** 16-bit
- **Accuracy** ± 0.1% of FSR (Voltage) at 25°C
± 0.2% of FSR (Current) at 25°C
- **Sampling Rate** 10 sample/second (total)
- **CMR @ 50/60 Hz** 92 dB
- **NMR @ 50/60 Hz** 60 dB
- **High Common Mode** 200 V_{DC}

Ordering Information

- **ADAM-6218** 6-ch Isolated Thermocouple Input Modbus TCP Module

Specifications

Analog Output

- **Channels** 4
- **Output Impedance** 2.1 Ω
- **Output Settling Time** 20 μs
- **Driving Load** Voltage: 2kΩ
Current: 500 Ω
- **Programmable Output Slope** 0.125 ~ 128 mA/sec
- **Output Type** 0.0625 ~ 64 V/sec
V, mA
- **Output Range** 0 ~ 5 V, 0 ~ 10 V, ±5 V, ±10 V, 0 ~ 20 mA, 4 ~ 20 mA
- **Accuracy** ± 0.3% of FSR (Voltage) at 25°C
± 0.5% of FSR (Current) at 25°C
- **Resolution** 12-bit
- **Current Load Resistor** 0 ~ 500 Ω
- **Drift** ± 50 ppm/°C
- **Digital Input**
- **Channels** 4 (Dry Contact only)
- **Dry Contact** Logic 0: Open
Logic 1: Closed to DGND
- **Support DI Filter**
- **Support Inverted DI Status**
- **Support Trigger to Startup or Safety Value**

Ordering Information

- **ADAM-6224** 4-ch Isolated Analog Output Modbus TCP Module

Common Specifications

General

- **Ethernet** 2-port 10/100 Base-TX (for Daisy Chain)
- **Protocol** Modbus/TCP, TCP/IP, UDP, HTTP, DHCP
- **Connector** Plug-in 5P/15P screw terminal blocks
- **Power Input** 10 ~ 30 V_{DC} (24 V_{DC} standard)
- **Watchdog Timer** System (1.6 seconds)
Communication (Programmable)
- **Dimensions** 110 x 60 x 27 mm
- **Protection** Built-in TVS/ESD protection
Power Reversal protection
Over Voltage protection: +/- 35V_{DC}
Isolation protection: 2500 V_{DC}
- **Power Consumption** ADAM-6217: 3.5W @ 24 V_{DC}
ADAM-6218: 3.5W @ 24 V_{DC}
ADAM-6224: 6W @ 24 V_{DC}

Features

- Daisy chain connection with auto-bypass protection
- Remote monitoring and control with smart phone/pad
- Group configuration capability for multiple module setup
- Flexible user-defined Modbus address
- Intelligent control ability by Peer-to-Peer and GCL function
- Multiple protocol support: Modbus TCP, TCP/IP, UDP, HTTP, DHCP
- Web language support: XML, HTML 5, JavaScript
- System configuration backup
- User Access Control

Environment

- **Operating Temperature** -10 ~ 70°C (14 ~ 158°F)
- **Storage Temperature** -20 ~ 80°C (-4 ~ 176°F)
- **Operating Humidity** 20 ~ 95% RH (non-condensing)
- **Storage Humidity** 0 ~ 95% RH (non-condensing)

ADAM-6250

ADAM-6251

ADAM-6256

15-ch Isolated Digital I/O Modbus TCP Module

16-ch Isolated Digital Input Modbus TCP Module

16-ch Isolated Digital Output Modbus TCP Module



NEW

ADAM-6250

FCC CE



NEW

ADAM-6251

FCC CE



NEW

ADAM-6256

FCC CE

Specifications

Digital Input

- **Channels** ADAM-6250: 8
ADAM-6251: 16
- **Dry Contact** Logic 0: Open
Logic 1: Closed to DGND
- **Wet Contact** Logic 0: 0 ~ 3 V_{DC} or 0 ~ -3 V_{DC}
Logic 1: 10 ~ 30 V_{DC} or -10 ~ -30 V_{DC}
(Dry/Wet Contact decided by Switch)
- **Input Impedance** 5.2 kΩ (Wet Contact)
- **Transition Time** 0.2 ms
- **Frequency Input Range** 0.1 ~ 3kHz
- **Counter Input** 3kHz (32 bit + 1 bit overflow)
- **Keep/Discard Counter Value when power off**
- **Supports Inverted DI Status**

Digital Output

- **Channels** ADAM-6250: 7 (Sink Type)
ADAM-6256: 16 (Sink Type)
- **Output Voltage Range** 10 ~ 30 V_{DC}
- **Normal Output Current** 100 mA (per channel)
- **Pulse Output** Up to 5kHz
- **Delay Output** High-to-Low and Low-to-High

Ordering Information

- **ADAM-6250** 15-ch Isolated Digital I/O Modbus TCP Module
- **ADAM-6251** 16-ch Isolated Digital Input Modbus TCP Module
- **ADAM-6256** 16-ch Isolated Digital Output Modbus TCP Module



ADVANTECH
Premier Partner

Vertrieb durch

AMC – Analytik & Messtechnik GmbH Chemnitz

Heinrich-Lorenz-Str. 55 Tel.: +49/371/38388-0
09120 Chemnitz Fax: +49/371/38388-99
E-Mail: info@amc-systeme.de Web: www.amc-systeme.de

Common Specifications

General

- **Ethernet** 2-port 10/100 Base-TX (for Daisy Chain)
- **LED Indication** ADAM-6250: 8 DI + 7 DO
ADAM-6251: 16 DI
ADAM-6256: 16 DO
- **Protocol** Modbus/TCP, TCP/IP, UDP, HTTP, DHCP
- **Connector** Plug-in 5P/15P screw terminal blocks
- **Power Input** 10 - 30 V_{DC} (24 V_{DC} standard)
- **Watchdog Timer** System (1.6 seconds)
Communication (Programmable)
- **Dimensions** 110 x 60 x 27 mm
- **Protection** Built-in TVS/ESD protection
Power Reversal protection
Over Voltage protection: +/- 35V_{DC}
Isolation protection: 2500 V_{DC}
- **Power Consumption** ADAM-6250: 3 W @ 24 V_{DC}
ADAM-6251: 2.7 W @ 24 V_{DC}
ADAM-6256: 3.2 W @ 24 V_{DC}

Features

- Daisy chain connection with auto-bypass protection
- Remote monitoring and control with smart phone/pad
- Group configuration capability for multiple module setup
- DI/O LED Indication
- Flexible user-defined Modbus address.
- Intelligent control ability by Peer-to-Peer and GCL function
- Multiple protocol support: Modbus TCP, TCP/IP, UDP, HTTP, DHCP
- Web language support: XML, HTML 5, Java Script
- System configuration backup
- User Access Control

Environment

- **Operating Temperature** -10 ~ 70°C (14 ~ 158°F)
- **Storage Temperature** -20 ~ 80°C (-4 ~ 176°F)
- **Operating Humidity** 20 ~ 95% RH (non-condensing)
- **Storage Humidity** 0 ~ 95% RH (non-condensing)

ADAM-6260

ADAM-6266

6-ch Relay Output Modbus TCP Module
4-ch Relay Output Modbus TCP Module with 4-ch DI

NEW



NEW



ADVANTECH
Premier Partner

Vertrieb durch **AAC**
AMC – Analytik & Messtechnik GmbH Chemnitz
 Heinrich-Lorenz-Str. 55 Tel.: +49/371/38388-0
 09120 Chemnitz Fax: +49/371/38388-99
 E-Mail: info@amc-systeme.de Web: www.amc-systeme.de

ADAM-6260



ADAM-6266



Specifications

Relay Output

- **Channels** ADAM-6260: 5 Form C and 1 Form A
ADAM-6266: 4 Form C
- **Contact Rating** 250 V_{AC} @ 5A
30 V_{DC} @ 5A
- **Max. Switching Voltage** 400 V_{AC}
300 V_{DC}
- **Breakdown Voltage** 500 V_{AC} (50/60Hz)
- **Max. Breakdown Capacity** 1250 VA
- **Frequency of Operation** 360 operations/hour with load
72,000 operations/hour without load
- **Set/Reset Time** 8 ms/8 ms
- **Mechanical Endurance** > 15 x 10⁶ operations
- **Isolation between Contact** 1000 V_{ms}
- **Insulation Resistance** > 10 GΩ @ 500 V_{DC}

Digital Input

- **Channels** ADAM-6266: 4
- **Dry Contact** Logic 0: Open
Logic 1: Closed to DI COM
- **Wet Contact** Logic 0: 0 ~ 3 V_{DC} or 0 ~ -3 V_{DC}
Logic 1: 10 ~ 30 V_{DC} or -10 ~ -30 V_{DC}
(Dry/Wet Contact decided by Switch)
- **Input Impedance** 5.2 kΩ (Wet Contact)
- **Transition Time** 0.2 ms
- **Frequency Input Range** 0.1 ~ 3kHz
- **Counter Input** 3kHz (32 bit + 1 bit overflow)
- **Keep/Discard Counter Value when power off**
- **Supports Inverted DI Status**

Ordering Information

- **ADAM-6260** 6-ch Relay Output Modbus TCP Module
- **ADAM-6266** 4-ch Relay Output Modbus TCP Module with 4-ch DI

Common Specifications

General

- **Ethernet** 2-port 10/100 Base-TX (for Daisy Chain)
- **LED Indication** ADAM-6260: 6 RL
ADAM-6266: 4 RL + 4 DI
- **Protocol** Modbus/TCP, TCP/IP, UDP, HTTP, DHCP
- **Connector** Plug-in 5P/15P screw terminal blocks
- **Power Input** 10 - 30 V_{DC} (24 V_{DC} standard)
- **Watchdog Timer** System (1.6 seconds)
Communication (Programmable)
- **Dimensions** 110 x 60 x 27 mm
- **Protection** Built-in TVS/ESD protection
Power Reversal protection
Over Voltage protection: +/- 35V_{DC}
Isolation protection: 2500 V_{DC}
ADAM-6260: 4.5 W @ 24 V_{DC}
ADAM-6266: 4.2 W @ 24 V_{DC}
- **Power Consumption**

Features

- Daisy chain connection with auto-bypass protection
- Remote monitoring and control with smart phone/pad
- Group configuration capability for multiple module setup
- DI/O LED Indication
- Flexible user-defined Modbus address.
- Intelligent control ability by Peer-to-Peer and GCL function
- Multiple protocol support: Modbus TCP, TCP/IP, UDP, HTTP, DHCP
- Web language support: XML, HTML 5, Java Script
- System configuration backup
- User Access Control

Environment

- **Operating Temperature** -10 ~ 70°C (14 ~ 158°F)
- **Storage Temperature** -20 ~ 80°C (-4 ~ 176°F)
- **Operating Humidity** 20 ~ 95% RH (non-condensing)
- **Storage Humidity** 0 ~ 95% RH (non-condensing)